

# 6600 Wiring Diagram and Notes:

## Wiring Diagram:

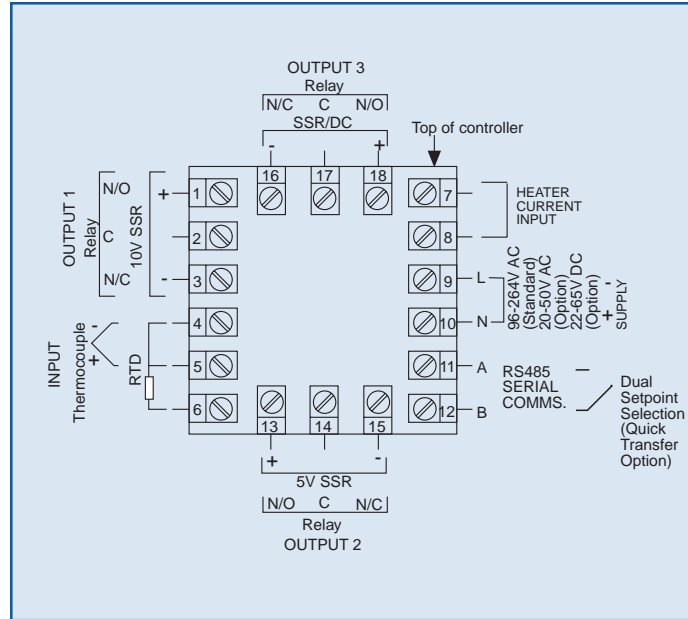

## Notes:

---

---

---

---

---

---

---